



# Agilent E5071C ENA Network Analyzer

**9 kHz to 4.5/6.5/8.5 GHz**

---

**100 kHz to 4.5/6.5/8.5 GHz  
(with bias tees)**

---

**300 kHz to 14/20 GHz  
(with bias tees)**

*The industry standard in  
RF network analysis*



**Agilent Technologies**

# ENA – New Standards in Speed, Accuracy and Versatility

*Agilent's E5071C ENA network analyzers deliver new standards in speed, accuracy and versatility for RF network analysis. Designed with a wide range of measurement capability to meet multiple network analysis needs, the ENA offers efficiency and flexibility for both manufacturing and R&D applications in industries such as wireless communication, automotive, semiconductor, and medical.*



## **Key features**

- ▶ Wide frequency coverage: 9 kHz to 20 GHz
  - ▶ Low trace noise: < 0.004 dB rms at 70 kHz IFBW
  - ▶ Wide dynamic range: > 123 dB
  - ▶ Fast measurement speed: 9 msec for 401 points with error correction
  - ▶ High temperature stability: 0.005 dB/°C
- 
- 2 or 4 ports, plus flexible multiport configuration of up to 22 ports with E5092A
  - Built-in VBA programming environment enables high throughput and UI customization
  - Powerful analysis and error correction
  - Advanced characterization of mixers (such as the vector mixer calibration) and amplifiers with frequency offset mode (optional)
  - Advanced characterization of high-speed serial interconnects with enhanced time domain analysis (optional)
  - Upgrade are available for all E5071C options at any time



# Flexible Test Port Architecture for a Variety of Applications

Select the number of ports, frequency and bias tees to fit your application

Number of ports	Frequency range						Option numbers			
	9 kHz	100 kHz	300 kHz	50 MHz	4.5 GHz	6.5 GHz		8.5 GHz	14 GHz	20 GHz
 <p><b>2-Port</b></p>										E5071C-240
				with bias tees						E5071C-245
										E5071C-260
				with bias tees						E5071C-265
										E5071C-280
				with bias tees						E5071C-285
				with bias tees						E5071C-2D5
				with bias tees						E5071C-2K5
 <p><b>4-Port</b></p>										E5071C-440
				with bias tees						E5071C-445
										E5071C-460
				with bias tees						E5071C-465
										E5071C-480
				with bias tees						E5071C-485
				with bias tees						E5071C-4D5
				with bias tees						E5071C-4K5
 <p><b>22-Port</b></p>										E5071C-440 or -445 E5092A
										E5071C-460 or -465 E5092A
										E5071C-480 or -485 E5092A
										E5071C-4D5 E5092A
										E5071C-4K5 E5092A

## Express ENA

E5071CEP Express ENA is ready for off-the-shelf delivery from our authorized distributors. Preconfigured with popular features, the express configurations deliver the same specifications and functionality as Agilent's build-to-order instruments. For more information on E5071CEP, visit [www.agilent.com/find/express-e5071c](http://www.agilent.com/find/express-e5071c).

# Enhanced Usability Increases Efficiency in R&D & Manufacturing

Providing the latest in modern technology, Agilent ENA network analyzers provide the performance and features needed in R&D and manufacturing for wide range of applications.



**Class largest (10.4 inches) XGA color LCD with touch screen**

**160 measurement channels and 16 measurement traces**

**Intuitive user interface: hard keys, soft keys, and pull-down menus**

**Removable HDD for secure environments (optional)**

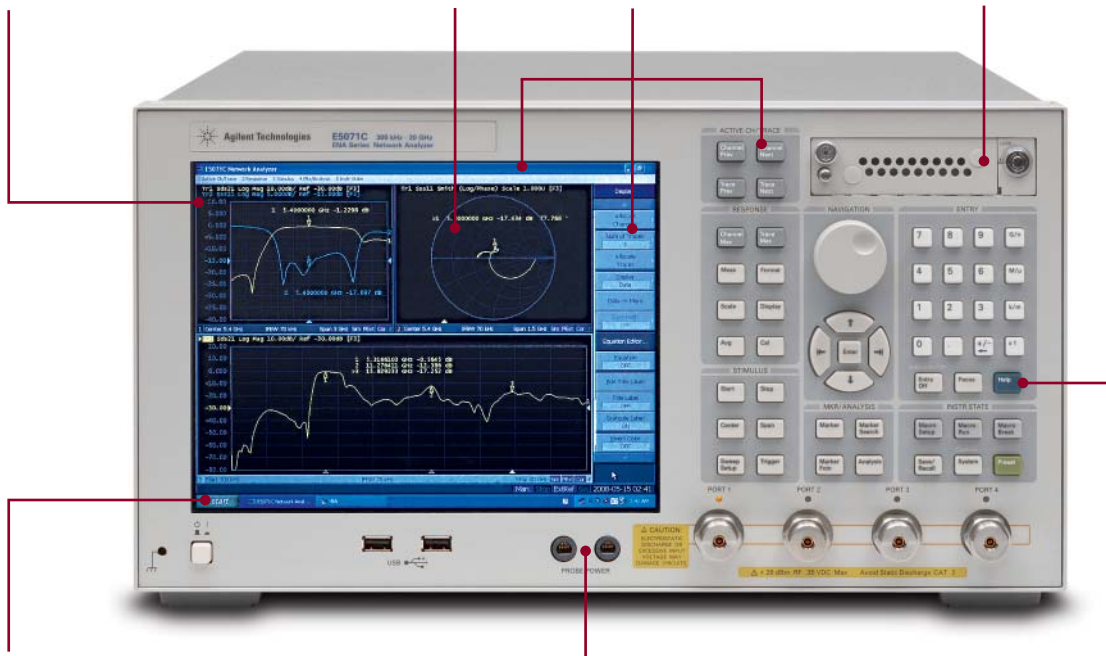

**Windows® Operating system**

**Dual probe power source**

*The ENA's intuitive user interface lets you easily set up complex measurements and quickly retrieve measurement data.*

**Context sensitive embedded help**

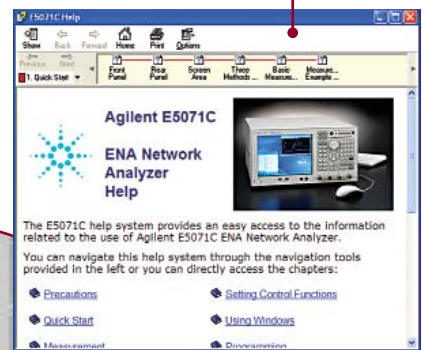
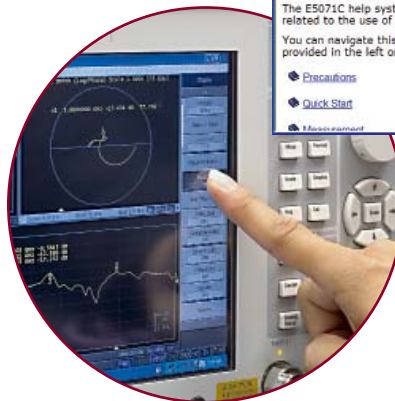

# ENA – New Standards in Speed and Accuracy

Agilent's new generation of network analyzers meets and exceeds what was possible with the 8753 family. Carrying on the family tradition, the ENA delivers new standards in speed, accuracy and versatility for RF network analysis.

## Wide dynamic range

>123 dB dynamic range provides more precise evaluation of high rejection filters.

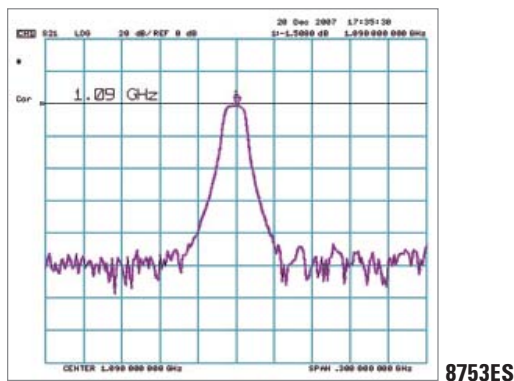
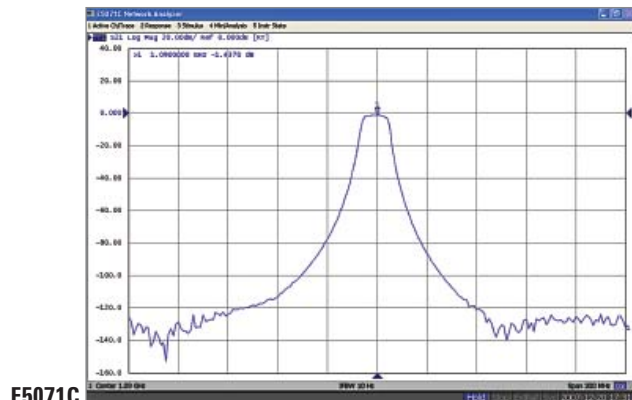

Dynamic range comparison: IFBW = 10Hz

## Low trace noise

<0.004 dBrms at 70 kHz IFBW helps minimize errors when measuring high-quality, low loss devices.

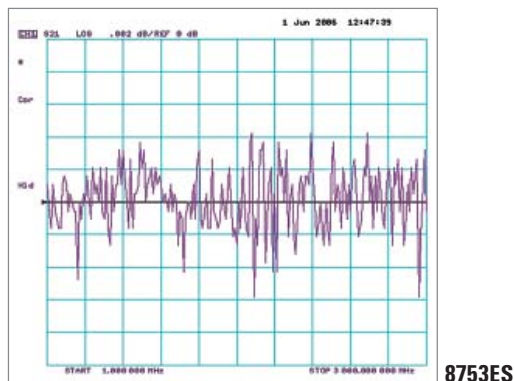
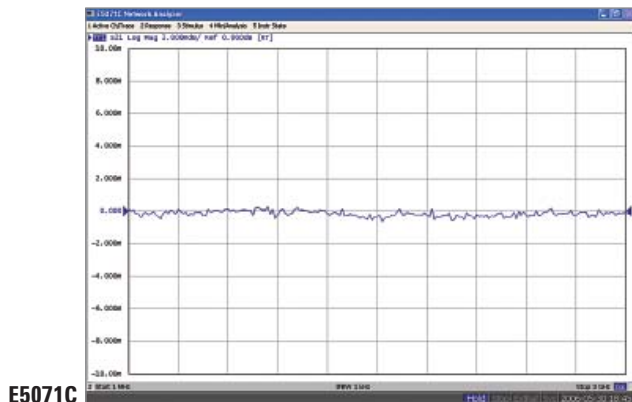

Trace noise comparison: IFBW = 1 kHz

## High stability

4 times better long-term temperature stability than the 8753ES for more confident evaluations.

E5071C 0.005 dB/°C

8753ES 0.02 dB/°C

Stability versus temperature

## Fast measurement speed

More than 20 times faster than the 8753ES to increase your throughput and lower your cost per component.

E5071C 41 msec

8753ES 848 msec

Measurement speed comparison:  
1601 pts, Full-2 port cal, 1 GHz to 1.2 GHz  
IFBW = 6 kHz (8753ES), 500 kHz (E5071C)



# Enhanced Measurement Capability for a Variety of Applications

The Agilent E5071C ENA combines the highest RF performance with powerful analysis capabilities and automated test tools that increase test efficiency and yield.

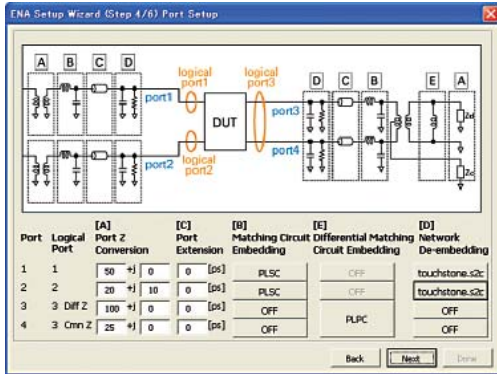

Fixture simulator settings with the setup wizard

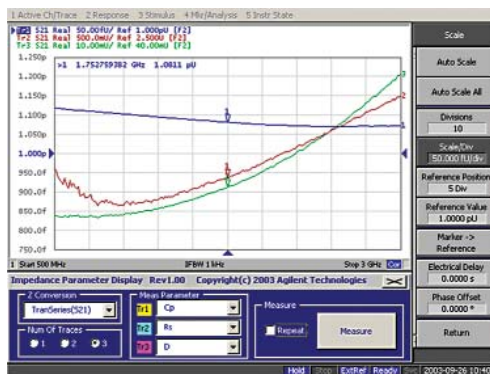

Impedance value display



High-performance ECal modules dramatically simplify the calibration process

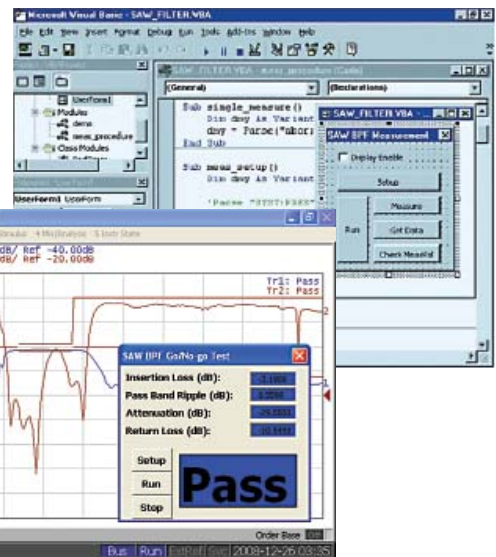

Built-in VBA programming and customizable user interface

## Powerful analysis capabilities

- ▼ Fixture simulator for
  - Mixed-mode S-parameter measurements<sup>1</sup>
  - Embedding and de-embedding
  - Matching circuit simulation
  - Port impedance conversion
- ▼ Equation editor for real-time data processing
- ▼ Time-domain analysis (optional)
- ▼ Enhanced time domain analysis (optional)
- ▼ Absolute value measurement
- ▼ 75 Ω measurement with a minimum loss pad
- ▼ Modeling devices with Agilent Advanced Design System (ADS) and IC-CAP
- ▼ Dielectric and magnetic properties measurement with Agilent materials measurement software

1. 4-port option required.

2. E5071C-008 frequency offset mode required.

## State-of-art calibration techniques

- ▼ Up to full 4-port SOLT, TRL, or unknown thru calibration
- ▼ Automatic port extension
- ▼ Adapter removal or insertion
- ▼ ECal module with various connector types or user-characterized ECal for use with any adapter
- ▼ Scalar mixer calibration and patented vector mixer calibration<sup>2</sup>

## Test automation tools

- ▼ Easy-to-use built-in VBA programming environment for fast post data processing
- ▼ Measurement Wizard Assistant (MWA) software for multiport measurement system (optional)
- ▼ Pre-defined limit test functions for pass/fail testing in production

## ■ Accurate and efficient component design and verification

### Circuits

With a combination of speed, accuracy, and advanced functionality, the ENA provides powerful general-purpose network analysis. The ENA offers extensive measurement capabilities, analysis features, and post data processing capabilities for effective design characterization.

The ENA has real-time fixture simulation capability, which lets you specify components as they are used in actual circuits. Bundled VBA macros and analysis functions enable fast, easy post data processing. Measured data is easily shared with EDA tools, such as Agilent's Advanced Design System (ADS). This enables you to quickly link measurement results back to your simulations to improve your designs and accelerate design verification.

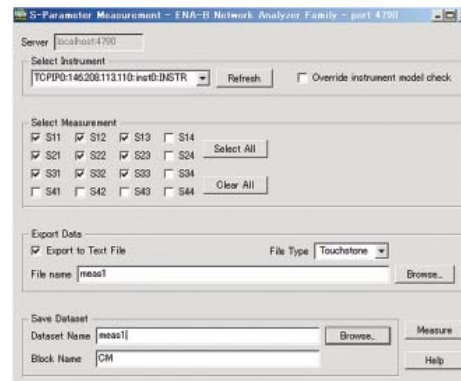
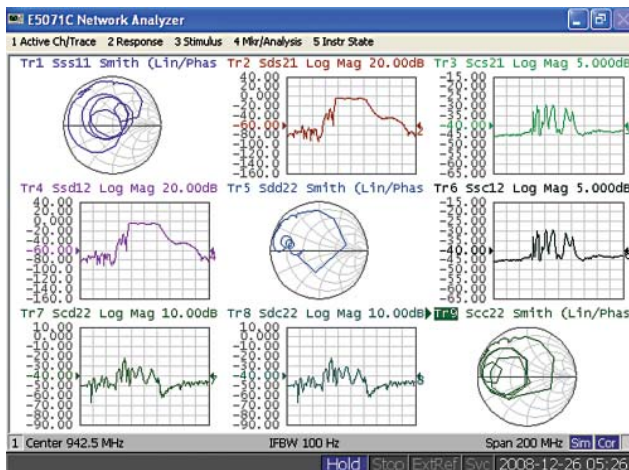
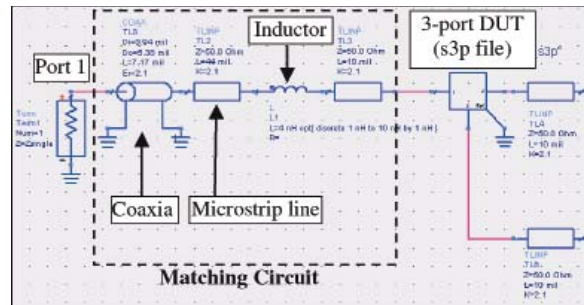
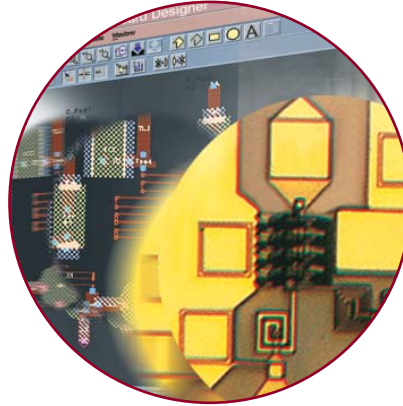

### Industry-leading RF performance

*Design high-performance products with confidence.*

- ▼ State-of-the-art calibration techniques for the highest measurement accuracy
- ▼ Automatic port extension for in-fixture devices
- ▼ Fixture simulator for embedding or de-embedding user-defined circuits

**Application Note:** Network Analysis – Calibration - Specifying Calibration Standards and Kits for Agilent Network Analyzers, AN 1287-11, [5989-4840EN](http://cp.literature.agilent.com/litweb/pdf/5989-4840EN.pdf) <http://cp.literature.agilent.com/litweb/pdf/5989-4840EN.pdf>

**Application Note:** Network Analysis – De-embedding and Embedding S-parameter Networks Using a Vector Network Analyzer, AN 1364-1, [5980-2784EN](http://cp.literature.agilent.com/litweb/pdf/5980-2784EN.pdf) <http://cp.literature.agilent.com/litweb/pdf/5980-2784EN.pdf>

### Accelerate design verification

*Simplify complicated measurement procedures and reduce your test program development time.*

- ▼ Free sample programs on the Agilent Web site
- ▼ Equation editor for real-time data processing
- ▼ Powerful connectivity with Windows OS; USB, LAN, GPIB, and a Web based remote user interface

### Completely upgradeable at any time

*Keep up with rapidly changing device requirements and parameters.*

- ▼ Upgrade to current E5071C hardware or software options at any time

## ■ Industry-leading RF performance for the highest throughput and yield

### Passive components

The ENA is ideal for high-volume passive component test. Superior measurement performance contributes the highest throughput increasing your production capability. High repeatability and stability improve test yield.



### Best-in-class RF performance

*Increase test throughput and reduce the overall cost of test.*

- ▼ Fast measurement speed
- ▼ Built-in VBA for easy automation and fast data processing
- ▼ Pre-defined limit test functions to meet your test requirements
- ▼ Segment sweep function to optimize stimulus setting
- ▼ ECal for reduced calibration times

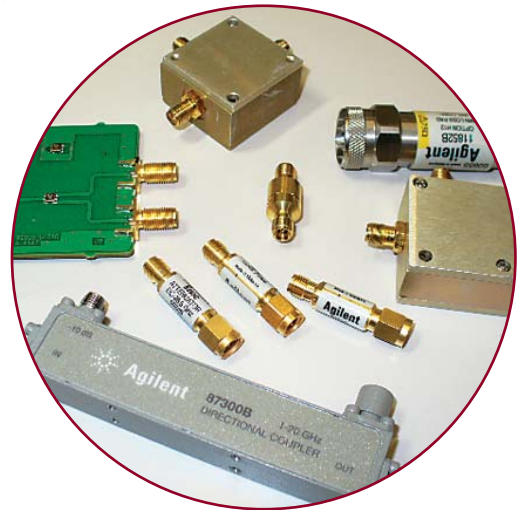

### High repeatability increases test yields

*Improve test yields with superior measurement performance.*

- ▼ Low trace noise
- ▼ Wide dynamic range
- ▼ High temperature stability

### Easy, accurate in-fixture calibration

*Reduce measurement errors.*

- ▼ 4-port TRL calibration for multiport calibration
- ▼ Automatic port extension (APE) for easy calibration
- ▼ Adapter removal/insertion for accurate mixed-connector calibration

**Application note:** Evolution of Test Automation Using the Built-In VBA with the ENA Series RF Network Analyzers, **5988-6192EN** <http://cp.literature.agilent.com/litweb/pdf/5988-6192EN.pdf>



# Basic and advanced measurement utilities enable through device characterization

## Amplifiers

RF amplifiers are used in a wide variety of industries. Whether characterizing the amplifier performance for wireless communication systems, medical equipment or automotive use, their characterization is always a significant stage in the design and verification process of complete systems.

The ENA features the basic measurement fundamentals for P1dB, PAE or K-factor as well as advanced techniques and built-in functions that simplify the total characterization of your amplifiers.

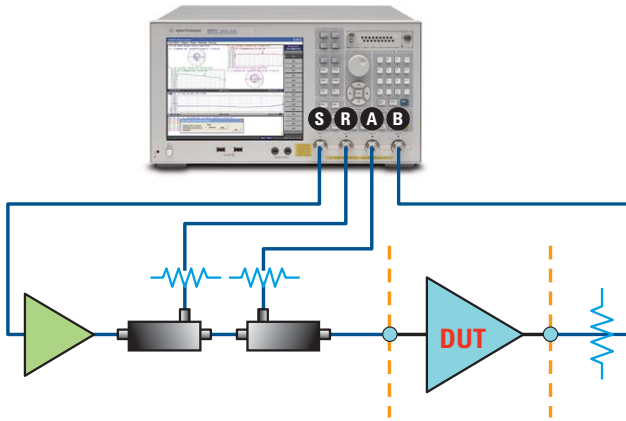

High-power measurement using external test set mode

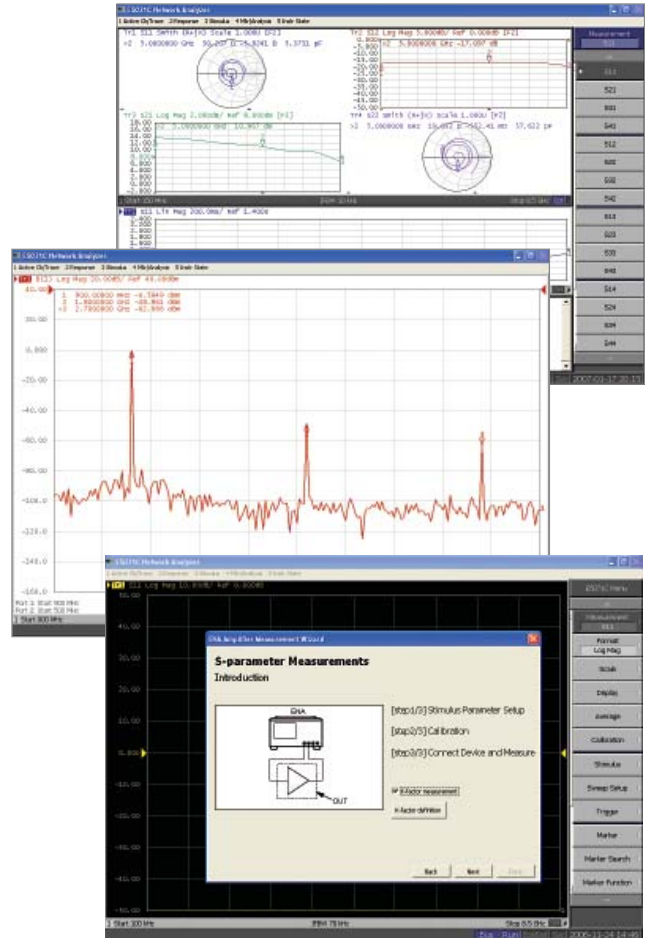

### Advanced measurement utilities

Simplify the total characterization of your amplifiers with built-in functions.

- ▼ DC voltage measurement capability
- ▼ Built-in bias tee option
- ▼ External test set mode for high-power measurements
- ▼ Trigger lines for complicated testing

**Application note:** Advanced Measurement Techniques for RF Amplifiers Using Unique Functions of the Agilent E5071C ENA, [5989-6522EN](http://cp.literature.agilent.com/litweb/pdf/5989-6522EN.pdf) <http://cp.literature.agilent.com/litweb/pdf/5989-6522EN.pdf>

### Powerful data processing

Quickly and easily process post measurement data.

- ▼ Amplifier measurement wizard program
- ▼ Equation editor for user-defined parameters

### Easy software connectivity

Quickly link measurement results back to your simulations.

- ▼ Intuilink software
- ▼ ADS link with Advanced Design System software

# State-of-the-art measurement capability

## Mixers and converters

Frequency converting devices such as mixers are used in many applications. These components require unique measurement techniques because they have different frequencies at the input and output ports.

The ENA offers several measurement methods for accurate characterization of these devices. Advanced calibration methods including Agilent patented vector mixer calibration (VMC) provide more accurate measurement results of your devices than conventional calibration methods.

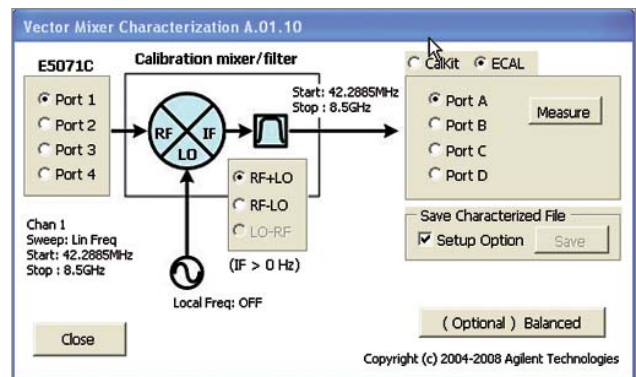
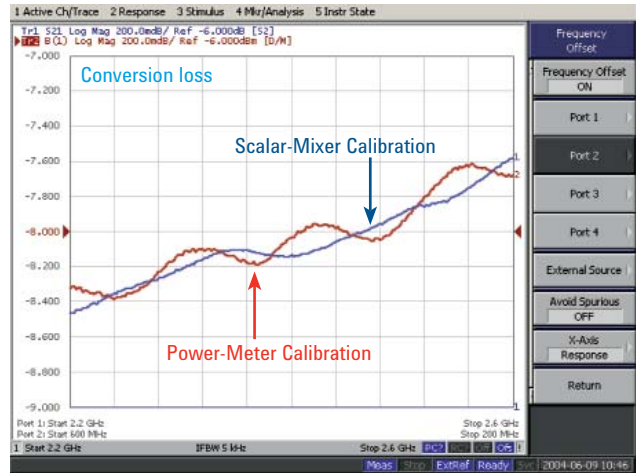
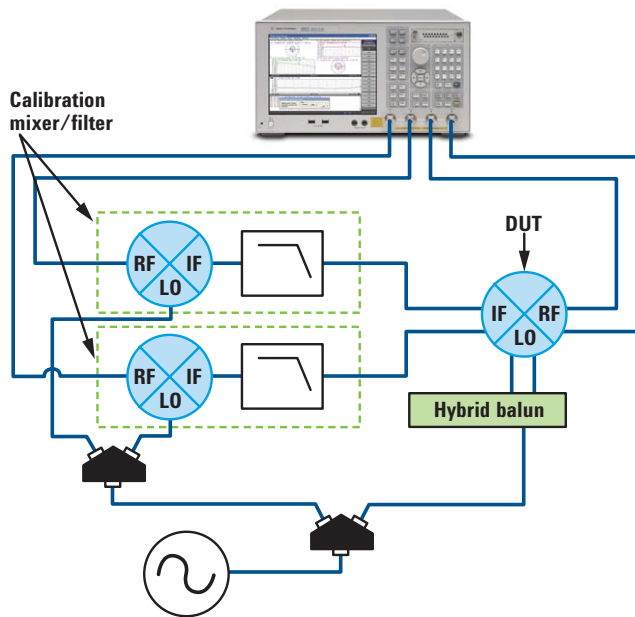

### Powerful built-in software functions

Reduce setup and measurement times.

- ▼ Frequency offset mode (FOM) option
- ▼ Balanced mixer measurement
- ▼ Absolute group delay measurement

### Easy-to-use analysis software

Reduce your operating time.

- ▼ Mixer measurement wizard program
- ▼ Vector mixer characterization program

### State-of-the-art calibration

Accurately characterize frequency converting devices.

- ▼ Power and receiver calibration
- ▼ Scalar mixer calibration (SMC) for match corrected amplitude measurement
- ▼ Vector mixer calibration (VMC) for single-ended and balanced mixer measurement

**Application Note:** Accurate Mixer Measurements Using the Frequency-Offset Mode, [5989-1420EN](http://cp.literature.agilent.com/litweb/pdf/5989-1420EN.pdf) <http://cp.literature.agilent.com/litweb/pdf/5989-1420EN.pdf>

## Expand your measurement capability with the ENA multiport solution

### Multiport devices

Today's devices often have multiple functionality integrated into a single component resulting in multiple RF ports. For multiport network analysis, measurement setup time is usually much longer than the actual testing time.

When the ENA is combined with the E5092A configurable multiport test set, they form comprehensive multiport solution. The ENA's Measurement Wizard Assistant (MWA) software simplifies complicated measurement procedures for multiport characterization.

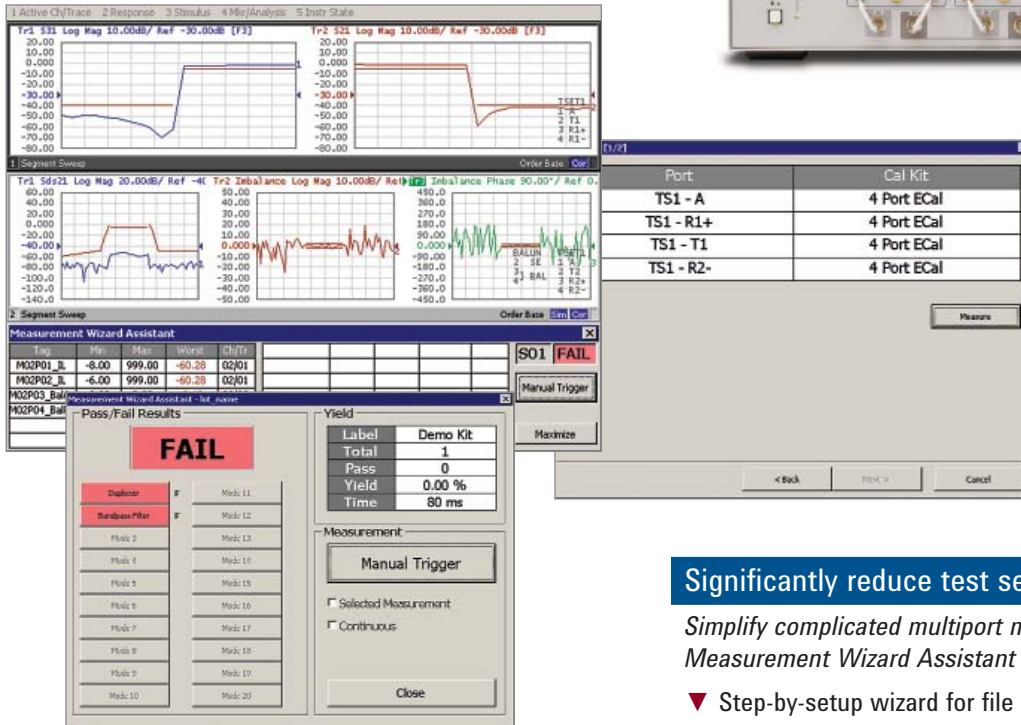

### Significantly reduce test setup times

Simplify complicated multiport measurements with Measurement Wizard Assistant software.

- ▼ Step-by-setup wizard for file setup
- ▼ Automatic parameter setup for the ENA
- ▼ Calibration wizard
- ▼ Detailed analysis of the measurement results

### Flexible multiport configuration

Meet the increasing, changing demands of multiport devices.

- ▼ E5092A configurable multiport test set
- ▼ Up to 10-port full crossbar measurement
- ▼ Up to 22-port measurement capability

### Easily expand up to 40 ports

Meet future demands with expandable multiport capability.

- ▼ Cascade two E5092As for more ports
  - Up to 16-port full crossbar measurement
  - Up to 40-port measurement capability

**Application Note:** Comprehensive Multiport Solution for the ENA Network Analyzer, **5989-8737EN** <http://cp.literature.agilent.com/litweb/pdf/5989-8737EN.pdf>  
**Application Note:** Measurement Wizard Assistant software, **5989-4855EN** <http://cp.literature.agilent.com/litweb/pdf/5989-4855EN.pdf>

## ■ Evaluate performance under actual working conditions

### EMC components

Electro-magnetic compatibility (EMC) is a key specification in broadband wireless communication and automotive electronics, where EMC components play an important role in meeting strict standard requirements. The ENA's powerful analysis functions help you determine the true performance of your product under the actual working conditions.

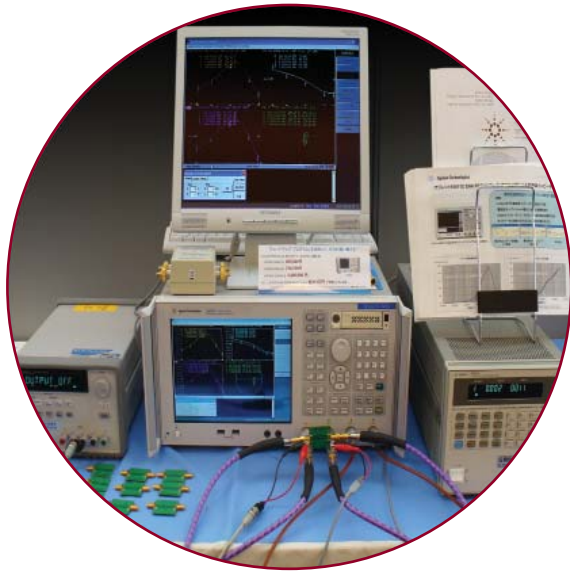

DC-biased measurement setup

### VBA sample programs

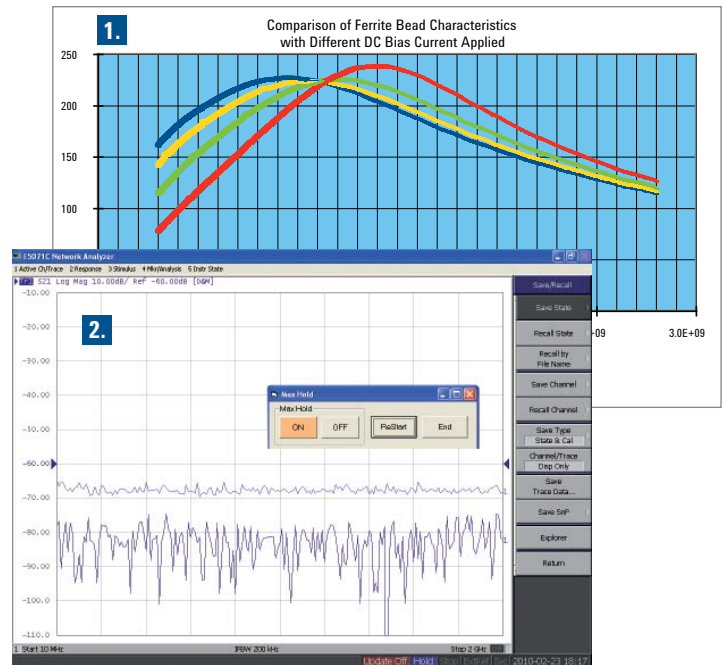

1. Evaluate EMC components, 2. Display MaxHOLD trace

### Broad operating frequency coverage

Evaluate a wide range of applications.

- ▼ Down to 9 kHz/100 kHz (with bias tees)
- ▼ Upgradeable to higher frequency

### Easy-to-use assistant programs

1. Evaluate EMC components under actual bias conditions VBA sample program.

- ▼ Impedance format display with bias current control function
- ▼ External DC source control via GPIB<sup>1</sup>/USB or LAN interface

2. Display MaxHOLD trace VBA sample program

- ▼ Both GUI and remote control functions are available<sup>2</sup>
- ▼ Useful for the EMC site evaluation and the site VSWR measurement. (eg. CISPR16-1-4)

### Powerful balance measurement analysis

Reduce the complexity of measurements for balanced components.

- ▼ 4-port embedding/de-embedding to remove unwanted fixture effects or to simulate circuit effects
- ▼ Impedance value display
- ▼ Common mode rejection ratio (CMRR) measurement

**Application Note:** Introduction to the Fixture Simulator Function of the ENA Series RF Network Analyzers: Network De-embedding/Embedding and Balanced Measurement, **5988-4923EN** <http://cp.literature.agilent.com/litweb/pdf/5988-4923EN.pdf>

1. Agilent 82357B USB-GPIB interface is necessary.
2. Display the maximum of any given active measurement. The held trace is displayed as a memory trace.



# ■ Obtain confidence in design through complete characterization of high-speed serial interconnects

## High-speed serial interconnects

As bit rates of digital systems increase, signal integrity of interconnects drastically affects system performance. Fast and accurate analysis of interconnect performance in both time and frequency domains become critical to ensure reliable system performance.

Because managing multiple test systems becomes difficult, a single test system that can fully characterize differential high speed digital devices is a very powerful tool.

The Enhanced time domain analysis option provides an one box solution for high speed interconnect analysis, enabling time domain, frequency domain, and eye diagram analysis.

The Enhanced time domain analysis option provides the following three breakthroughs for signal integrity design and verification:

- Simple and Intuitive Operation
- Fast and Accurate Measurements
- ESD Robustness

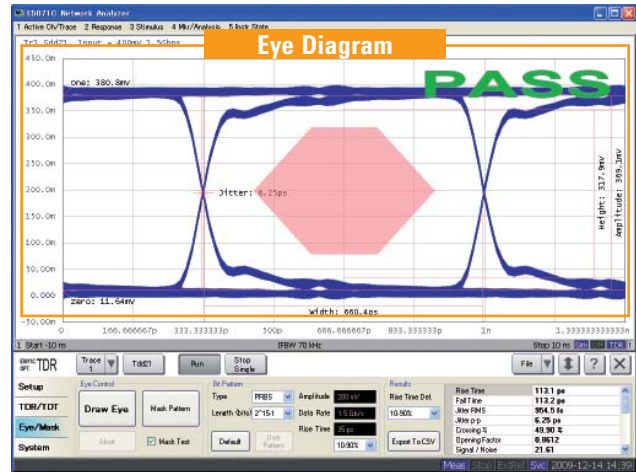

Simulated eye diagram analysis using the virtual bit pattern generator

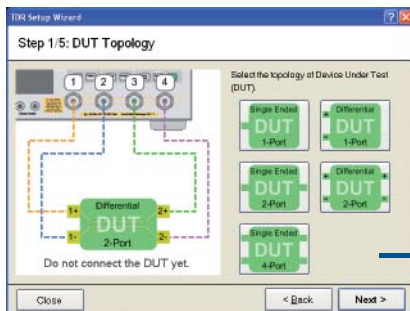

The Setup Wizard guides the user through all of the required steps.

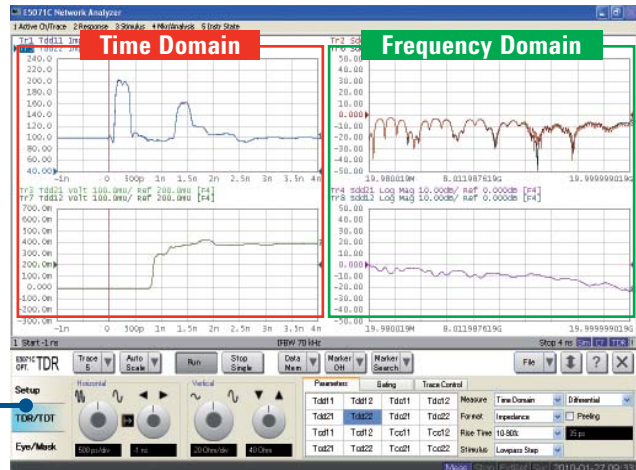

Simultaneous analysis of both time and frequency domains

## Simple and Intuitive Operation

*TDR oscilloscope look-and-feel.*

- ▼ Dedicated controls for common adjustments
- ▼ Automatic display allocation for most common measurement parameters
- ▼ The Setup Wizard guides the user through all the required steps, making setup, error correction, and measurement intuitive and error free

## ESD Robustness

*Protection circuits implemented inside the instrument.*

- ▼ Proprietary electrostatic discharge (ESD) protection chip to significantly increase ESD robustness, while at the same time maintaining excellent RF performance

## Fast and Accurate Measurements

*Delivers new standards in speed, accuracy, and versatility.*

- ▼ Wide dynamic range to observe the true performance of your device
- ▼ Low noise floor for accurate and repeatable measurements
- ▼ Fast measurement speed for real-time analysis
- ▼ State-of-the art calibration techniques to reduce measurement errors

For additional information regarding the Enhanced time domain analysis option, visit: [www.agilent.com/find/ena-tdr](http://www.agilent.com/find/ena-tdr)

## ■ Accurate, easy-to-use solution for on wafer test

### ***On-wafer measurements***

For successful evaluation of on-wafer semiconductor or RF MEMS devices, the total accuracy of your measurement system and easy operation are crucial. The ENA offers state-of-the-art features for accurate measurements and compatibility with many probe systems.

#### On-wafer measurements

*A complete solution for your on-wafer measurements.*

- ▼ Accurate calibration at probe tips
- ▼ Supported by IC-CAP and ADS connection manager
- ▼ Supported by popular on-wafer calibration software
- ▼ Two GSGSG probe contacts using a 4-port test set

**Application Note:** In-Fixture Characterization Using the ENA Series RF Network Analyzer with Cascade Microtech Probing System.  
<http://cp.literature.agilent.com/litweb/pdf/5988-6522EN.pdf>

For additional information regarding Cascade Microtech, visit:  
[www.cascademicrotech.com](http://www.cascademicrotech.com)

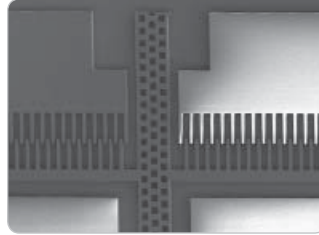

Agilent ENA and Cascade Sumimit 12000

## ■ Simplify material evaluation

### ***Material measurements***

Simplify your material test in the RF range by combining the ENA with ready-to-use Agilent Materials software and probe kits. The ENA's highly-accurate measurements will help you determine the highest performing materials for your application, shortening your design time.



85070E Dielectric Probe Kit





#### Dielectric Constant

*Measure the dielectric characteristics over a wide frequency range.*

- ▼ Supported by 85071E Material Measurement software and the 85070E probe system

For additional information regarding material software, visit:  
[www.agilent.com/find/materials](http://www.agilent.com/find/materials)

## ■ Key specifications

Item						
	E5071C Option 240/245/ 440/445	E5071C Option 260/265/ 460/465	E5071C Option 280/285/ 480/485	E5071C Option 2D5/4D5	E5071C Option 2K5/4K5	8753ES 3
Test frequency	9 or 100 kHz to 4.5 GHz	9 or 100 kHz to 6.5 GHz	9 or 100 kHz to 8.5 GHz	300 kHz to 14 GHz	300 kHz to 20 GHz	30 kHz to 6 GHz
Source power range <sup>1</sup>	–55 dBm to +10 dBm			–85 dBm to +10 dBm		–85 dBm to +10 dBm
Dynamic range	>123 dB					110 dB
Trace noise	< 0.004 dBrms					0.006 dBrms
Measurement speed <sup>2</sup>	41 ms					848 ms
Stability	0.005 dB/degree C					0.02 dB/ degree C
Interface	GPIB/LAN/USB					GPIB
Test port	2- or 4-port					2- or 3-port
Max number of points	20,001					1,601
Max number of channels	160					2
Calibration	SOLT, TRL, Adapter removal/insertion, Unknown thru, ECal, User characterized ECal, SMC, VMC					SOLT, TRL <sup>3</sup> , Adapter Removal
Web-enabled control	Yes					No
Fixture simulator	Yes					No
Built-in programming environment	VBA					No
Future enhancements /upgradeable	Yes					No
Filter tuning limit lines	Yes					Yes
Built-in bias tees	Yes					Yes
Probe power	Yes					Yes
DC measurements	Yes					Yes
Frequency offset mode option	Yes					Yes
Time-domain option	Yes					Yes

1. Maximum output power is changed according to measurement frequency.

2. 1601 points, Full two-port calibration, 1 GHz to 1.2 GHz, IFBW = 500 kHz (E5071C), 6 kHz (8753ES).

3. For more detail, refer to **Application Note: 7 Reasons to Upgrade from your 8753 to an ENA Network Analyzer, AN 1478, 5989-0206EN** <http://cp.literature.agilent.com/litweb/pdf/5989-0206EN.pdf>

For more details, refer to the ENA E5071C Network Analyzer Data Sheet, **5989-5479EN** <http://cp.literature.agilent.com/litweb/pdf/5989-5479EN.pdf>

## ■ Secure your assets

### Protecting your 8753 software investment

The E5071C has a 8753 code compatible mode in which the analyzer automatically translates the 8753's remote programming commands for operation on the E5071C. This enables you drop-in replacement in the automated test environment.<sup>1</sup>

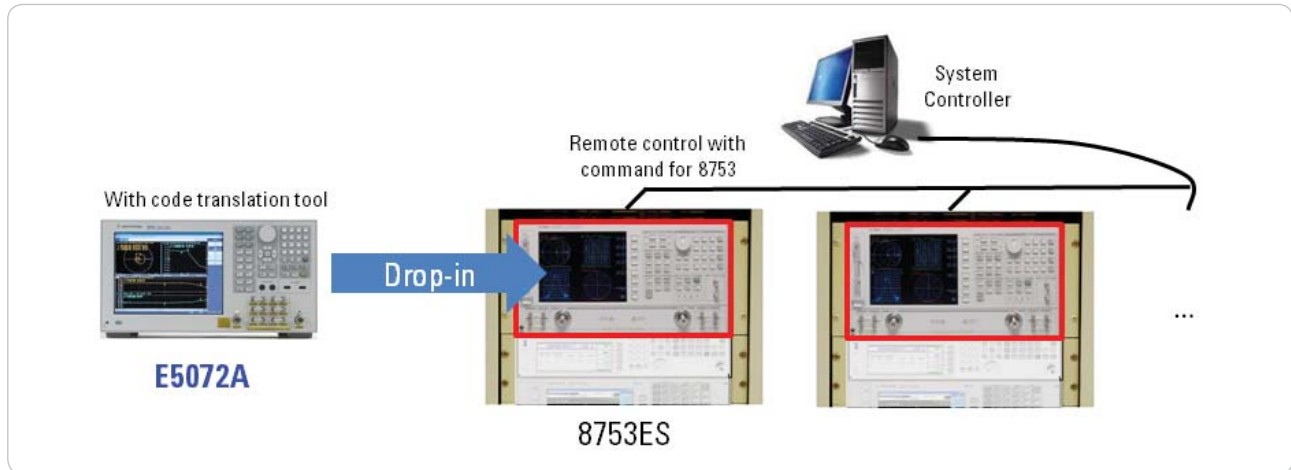

### Protecting your hardware investment

The E5071C is a safe investment because of its flexibility. You can easily upgrade any feature of the E5071C whenever you need the feature! This includes not only software options like time-domain mode, frequency offset mode, and MWA, but also hardware option such as frequency, test-port and high stability.

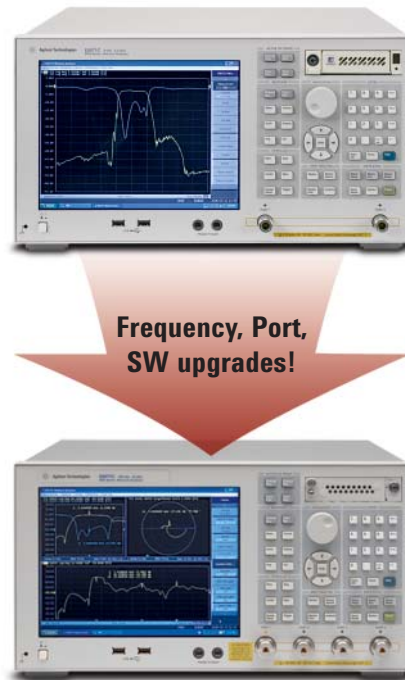

1. Contact your Agilent sales representatives for technical support.



## ■ Ordering information

### E5071C ENA network analyzer

**Option E5071C-240** 2-port test set, 9 kHz to 4.5 GHz  
*without bias tees*

**Option E5071C-245** 2-port test set, 100 kHz to 4.5 GHz  
*with bias tees*

**Option E5071C-440** 4-port test set, 9 kHz to 4.5 GHz  
*without bias tees*

**Option E5071C-445** 4-port test set, 100 kHz to 4.5 GHz  
*with bias tees*

**Option E5071C-260** 2-port test set, 9 kHz to 6.5 GHz  
*without bias tees*

**Option E5071C-265** 2-port test set, 100 kHz to 6.5 GHz  
*with bias tees*

**Option E5071C-460** 4-port test set, 9 kHz to 6.5 GHz  
*without bias tees*

**Option E5071C-465** 4-port test set, 100 kHz to 6.5 GHz  
*with bias tees*

**Option E5071C-280** 2-port test set, 9 kHz to 8.5 GHz  
*without bias tees*

**Option E5071C-285** 2-port test set, 100 kHz to 8.5 GHz  
*with bias tees*

**Option E5071C-480** 4-port test set, 9 kHz to 8.5 GHz  
*without bias tees*

**Option E5071C-485** 4-port test set, 100 kHz to 8.5 GHz  
*with bias tees*

**Option E5071C-2D5** 2-port test set, 300 kHz to 14 GHz  
*with bias tees*

**Option E5071C-4D5** 4-port test set, 300 kHz to 14 GHz  
*with bias tees*

**Option E5071C-2K5** 2-port test set, 300 kHz to 20 GHz  
*with bias tees*

**Option E5071C-4K5** 4-port test set, 300 kHz to 20 GHz  
*with bias tees*

### Additional Options

**Option E5071C-008** Frequency offset mode

**Option E5071C-TDR** Enhanced time domain analysis

**Option E5071C-010** Time domain analysis

**Option E5071C-790** Measurement Wizard Assistant software

**Option E5071C-1E5** High stability timebase

**Option E5071C-017** Removable hard disk drive

### E5092A Configurable multipoint test set

**Option E5092A 020** 20 GHz, up to 22-port configurable multipoint test set

For details, refer to the *ENA Network Analyzer Configuration Guide*,

<http://cp.literature.agilent.com/litweb/pdf/5989-5480EN.pdf>

## ■ Web resources

available on the ENA Web site: [www.agilent.com/find/ena](http://www.agilent.com/find/ena)  
Visit our Web sites for additional product information and literature.

- ENA series network analyzers:  
[www.agilent.com/find/ena](http://www.agilent.com/find/ena)
- ENA series service and support:  
[http://www.agilent.com/find/ena\\_support](http://www.agilent.com/find/ena_support)
- Sample VBA Library for ENA Series:  
<http://www.agilent.com/find/enavba>
- Balanced measurements:  
[www.agilent.com/find/balanced](http://www.agilent.com/find/balanced)
- Electronic calibration (ECal) modules:  
[www.agilent.com/find/ecal](http://www.agilent.com/find/ecal)
- Materials measurements:  
[www.agilent.com/find/materials](http://www.agilent.com/find/materials)
- Multipoint test sets:  
[www.agilent.com/find/multipoint](http://www.agilent.com/find/multipoint)
- Enhanced time domain analysis option:  
[www.agilent.com/find/ena-tdr](http://www.agilent.com/find/ena-tdr)
- Physical layer test systems:  
[www.agilent.com/find/plts](http://www.agilent.com/find/plts)
- PNA microwave network analyzers:  
[www.agilent.com/find/pna](http://www.agilent.com/find/pna)
- RF and microwave accessories:  
[www.agilent.com/find/accessories](http://www.agilent.com/find/accessories)
- \* RF and microwave network analysis and impedance probing:  
[www.agilent.com/find/probingrf](http://www.agilent.com/find/probingrf)
- RF and microwave network analyzer calibration resources:  
[www.agilent.com/find/nacal](http://www.agilent.com/find/nacal)

## ■ Literature

*ENA Series Data Sheet*,  
<http://cp.literature.agilent.com/litweb/pdf/5989-5479EN.pdf>

*ENA Series Configuration Guide*,  
<http://cp.literature.agilent.com/litweb/pdf/5989-5480EN.pdf>

*Network Analyzer Selection Guide*,  
<http://cp.literature.agilent.com/litweb/pdf/5989-7603EN.pdf>

*Test Solutions for Multipoint and Balanced Devices Selection Guide*,  
<http://cp.literature.agilent.com/litweb/pdf/5988-2461EN.pdf>



### Agilent Email Updates

[www.agilent.com/find/emailupdates](http://www.agilent.com/find/emailupdates)

Get the latest information on the products and applications you select.



[www.lxistandard.org](http://www.lxistandard.org)

LAN eXtensions for Instruments puts the power of Ethernet and the Web inside your test systems. Agilent is a founding member of the LXI consortium.

### Agilent Channel Partners

[www.agilent.com/find/channelpartners](http://www.agilent.com/find/channelpartners)

Get the best of both worlds: Agilent's measurement expertise and product breadth, combined with channel partner convenience.



Agilent Advantage Services is committed to your success throughout your equipment's lifetime. To keep you competitive, we continually invest in tools and processes that speed up calibration and repair and reduce your cost of ownership. You can also use Infoline Web Services to manage equipment and services more effectively. By sharing our measurement and service expertise, we help you create the products that change our world.

[www.agilent.com/find/advantageservices](http://www.agilent.com/find/advantageservices)



[www.agilent.com/quality](http://www.agilent.com/quality)

[www.agilent.com](http://www.agilent.com)  
[www.agilent.com/find/ena](http://www.agilent.com/find/ena)

For more information on Agilent Technologies' products, applications or services, please contact your local Agilent office. The complete list is available at:

[www.agilent.com/find/contactus](http://www.agilent.com/find/contactus)

#### Americas

Canada	(877) 894 4414
Brazil	(11) 4197 3500
Mexico	01800 5064 800
United States	(800) 829 4444

#### Asia Pacific

Australia	1 800 629 485
China	800 810 0189
Hong Kong	800 938 693
India	1 800 112 929
Japan	0120 (421) 345
Korea	080 769 0800
Malaysia	1 800 888 848
Singapore	1 800 375 8100
Taiwan	0800 047 866
Other AP Countries	(65) 375 8100

#### Europe & Middle East

Belgium	32 (0) 2 404 93 40
Denmark	45 70 13 15 15
Finland	358 (0) 10 855 2100
France	0825 010 700*
	*0.125 €/minute
Germany	49 (0) 7031 464 6333
Ireland	1890 924 204
Israel	972-3-9288-504/544
Italy	39 02 92 60 8484
Netherlands	31 (0) 20 547 2111
Spain	34 (91) 631 3300
Sweden	0200-88 22 55
United Kingdom	44 (0) 131 452 0200

For other unlisted Countries:

[www.agilent.com/find/contactus](http://www.agilent.com/find/contactus)

Revised: June 8, 2011

Product specifications and descriptions in this document subject to change without notice.

© Agilent Technologies, Inc. 2011  
Published in USA, September 28, 2011  
5989-5478EN

Microsoft® is a U.S. registered trademark of Microsoft Corporation.

Java™ is a U.S. trademark of Sun Microsystems, Inc.



**Agilent Technologies**